

ACTIQ Marketing 2002

Sales Training

March 2002

Christine Wells, APM

PLAINTIFFS TRIAL
EXHIBIT
P-03609_00001



Produced Pursuant to Confidentiality Agreement

CONFIDENTIAL PER STIPULATION AND PROTECTIVE ORDER
Confidential

CEPHEDPA-AP-01581387
Confidential Treatment Requested by Cephalon, Inc.
CEP_TPP_EDPA10190736

TEVA_MDL_A_05734046

P-03609_00001

Overview

- **Where have we been?**
 - ◆ Sales, TRx, Brand Concept
- **Where are we now?**
 - ◆ Sales, TRx, Brand Concept
- **2001 Performance Update**
- **Why ACTIQ in 2002?**
 - ◆ Differentiating Benefits / Positioning / Key Messages
- **2002 Key Marketing Issues**
- **Campaign Tracking Study Results**
- **Selected Tactics**

Actiq[®]
(oral transmucosal
fentanyl citrate)

Cephalon

Produced Pursuant to Confidentiality Agreement

CEPHEDPA-AP-01581388

Confidential Treatment Requested by Cephalon, Inc.

CEP_TPP_EDPA10190737

TEVA_MDL_A_05734047

CONFIDENTIAL PER STIPULATION AND PROTECTIVE ORDER

Confidential

P-03609 _ 00002

Where have we been?

Actiq[®]
(oral transmucosal
fentanyl citrate)

Produced Pursuant to Confidentiality Agreement

CONFIDENTIAL PER STIPULATION AND PROTECTIVE ORDER
Confidential

CEPHEDPA-AP-01581389
Confidential Treatment Requested by Cephalon, Inc.
CEP_TPP_EDPA10190738

TEVA_MDL_A_05734048

P-03609 _ 00003

History of ACTIQ

Anesta
 Acquires Cephalon
 ACTIQ Acquires
 AnestaAnesta
 "Launch"
 Abbott
 Launch
 FDA Approval
 Cephalon
 Re-Launch

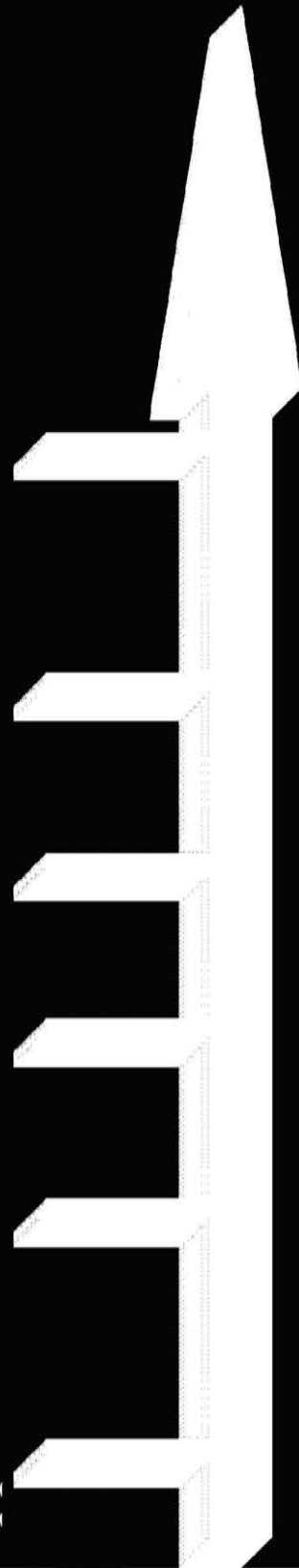

11/98 4/99 2/00 5/00 10/00 3/01

It is important to understand the history of ACTIQ to be able to create a comfort level with your physicians regarding product use and company support



Produced Pursuant to Confidentiality Agreement

CONFIDENTIAL PER STIPULATION AND PROTECTIVE ORDER
Confidential

CEPHEDPA-AP-01581390
Confidential Treatment Requested by Cephalon, Inc.
CEP_TPP_EDPA10190739

TEVA_MDL_A_05734049

P-03609 _ 00004

Prior to 2001 Cephalon Relaunch

- **Product Ownership Changes**
 - ✦ Lack of continuity – company support??
 - ✦ Negative product perception
- **Weak Concepts and Poor Product Positioning**
 - ✦ Concepts focused on OT delivery system and clinical entity of BTCP
 - ✦ Did not position product based on differentiating benefits
- **BTP Misunderstood**
 - ✦ Newer concept – not well understood, assessed, treated by many in pain community

Actiq®
(oral transmucosal
fentanyl citrate)

Cephalon

Produced Pursuant to Confidentiality Agreement

CEPHEDPA-AP-01581391

Confidential Treatment Requested by Cephalon, Inc.

CEP_TPP_EDPA10190740

TEVA_MDL_A_05734050

CONFIDENTIAL PER STIPULATION AND PROTECTIVE ORDER

Confidential

P-03609 _ 00005

2001 Major Challenges

- Do you get a second chance to make a first impression?
- Re-concept and reposition product after 2 years of minimal/poor support
 - Refocus targeting efforts
 - Improve product awareness and perception of ACTIQ's clear, differentiating benefits
 - Increase awareness of BTP among prescribers and patients: proper assessment and treatment

Actiq®
(oral transmucosal
fentanyl citrate)

Cephalon

Produced Pursuant to Confidentiality Agreement

CEPHEDPA-AP-01581392

Confidential Treatment Requested by Cephalon, Inc.

CEP_TPP_EDPA10190741

TEVA_MDL_A_05734051

CONFIDENTIAL PER STIPULATION AND PROTECTIVE ORDER

Confidential

P-03609 _ 00006

Where have we been?

■ 1999

✦ TRx	5,548
✦ Gross Sales	\$3.5 MM
✦ # of Reps	20

■ 2000

✦ TRx	26,259
✦ Gross Sales	\$16.0 MM
✦ # of Reps	48

NOW AVAILABLE
A DELIVERY
SYSTEM DESIGNED TO MAKE
A DIFFERENCE

Breakthrough oral transmucosal delivery

Actiq® (oral transmucosal
fentanyl citrate)

Important Warnings



- Only for the management of breakthrough cancer pain in patients with malignancies who are already receiving and who are tolerant to opioid therapy for their underlying persistent cancer pain.
- Because life-threatening hypoventilation could occur at any dose in patients not taking chronic opiates, Actiq is contraindicated in the management of acute or postoperative pain.
- This product must not be used in opioid non-tolerant patients.
- Instruct patients/caregivers Actiq can be fatal to a child. Keep open units from children and discard properly.

See boxed warning and full prescribing information on following pages.

Actiq is a registered trademark of Amgen Corp.

AMGEN Laboratories, Inc.
Molecular Products Division
9201 Park E. 90050-5174
© 2000 AMGEN, LTD.

 **Cephalon**

Actiq®
(oral transmucosal
fentanyl citrate)

Produced Pursuant to Confidentiality Agreement

CONFIDENTIAL PER STIPULATION AND PROTECTIVE ORDER
Confidential

CEPHEDPA-AP-01581393
Confidential Treatment Requested by Cephalon, Inc.
CEP_TTP_EDPA10190742

TEVA_MDL_A_05734052

Where are we now?

Actiq[®]
(oral transmucosal
fentanyl citrate)

Produced Pursuant to Confidentiality Agreement

CONFIDENTIAL PER STIPULATION AND PROTECTIVE ORDER
Confidential

CEPHEDPA-AP-01581394
Confidential Treatment Requested by Cephalon, Inc.
CEP_TPP_EDPA10190743

TEVA_MDL_A_05734053

P-03609 _ 00008

Where are we now?

■ 2001

- ★ TRx 73,514
- ★ Gross Sales \$55.0 MM
- ★ # of Reps 48

■ 2002

- ★ TRx 148K+
- ★ Gross Sales \$109 MM
- ★ # of Reps 60

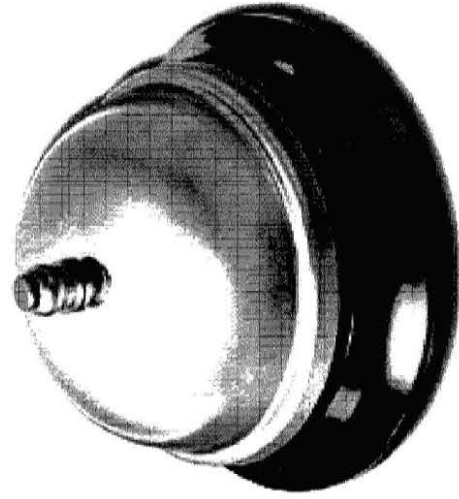

Actiq® on call.



Actiq®
(oral transmucosal
fentanyl citrate)

Cephalon

Produced Pursuant to Confidentiality Agreement

CONFIDENTIAL PER STIPULATION AND PROTECTIVE ORDER
Confidential

CEPHEDPA-AP-01581395
Confidential Treatment Requested by Cephalon, Inc.
CEP_TPP_EDPA10190744

TEVA_MDL_A_05734054

P-03609 _ 00009

Year-to-Year Growth Sales, TRx & % Increase

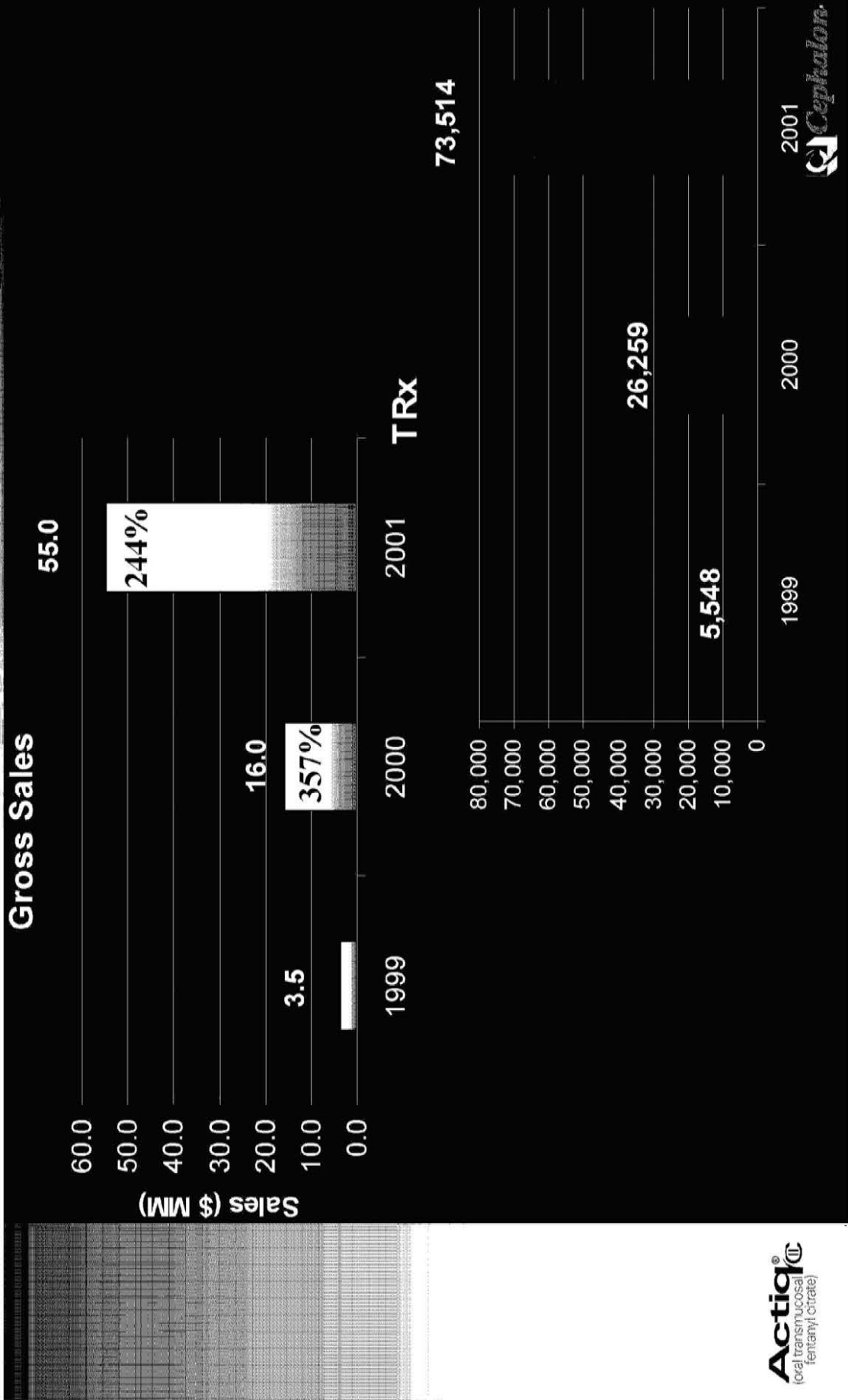

Produced Pursuant to Confidentiality Agreement

CONFIDENTIAL PER STIPULATION AND PROTECTIVE ORDER
Confidential

CEPHEDPA-AP-01581396
Confidential Treatment Requested by Cephalon, Inc.
CEP_TPP_EDPA10190745

TEVA_MDL_A_05734055

P-03609 _ 00010

2005 Performance Update

Actiq®
(oral transmucosal
fentanyl citrate)

Produced Pursuant to Confidentiality Agreement

CONFIDENTIAL PER STIPULATION AND PROTECTIVE ORDER
Confidential

CEPHEDPA-AP-01581397
Confidential Treatment Requested by Cephalon, Inc.
CEP_TPP_EDPA10190746

TEVA_MDL_A_05734056

P-03609 _ 00011

4 Key Business Drivers

- # of Prescribers
- # of TRx
- Units/Rx
- Dosage Strength of Rx



Produced Pursuant to Confidentiality Agreement

CONFIDENTIAL PER STIPULATION AND PROTECTIVE ORDER
Confidential

CEPHEDPA-AP-01581398
Confidential Treatment Requested by Cephalon, Inc.
CEP_TPP_EDPA10190747

TEVA_MDL_A_05734057

P-03609 _ 00012

Monthly Prescriber Count Trend and Post-Launch

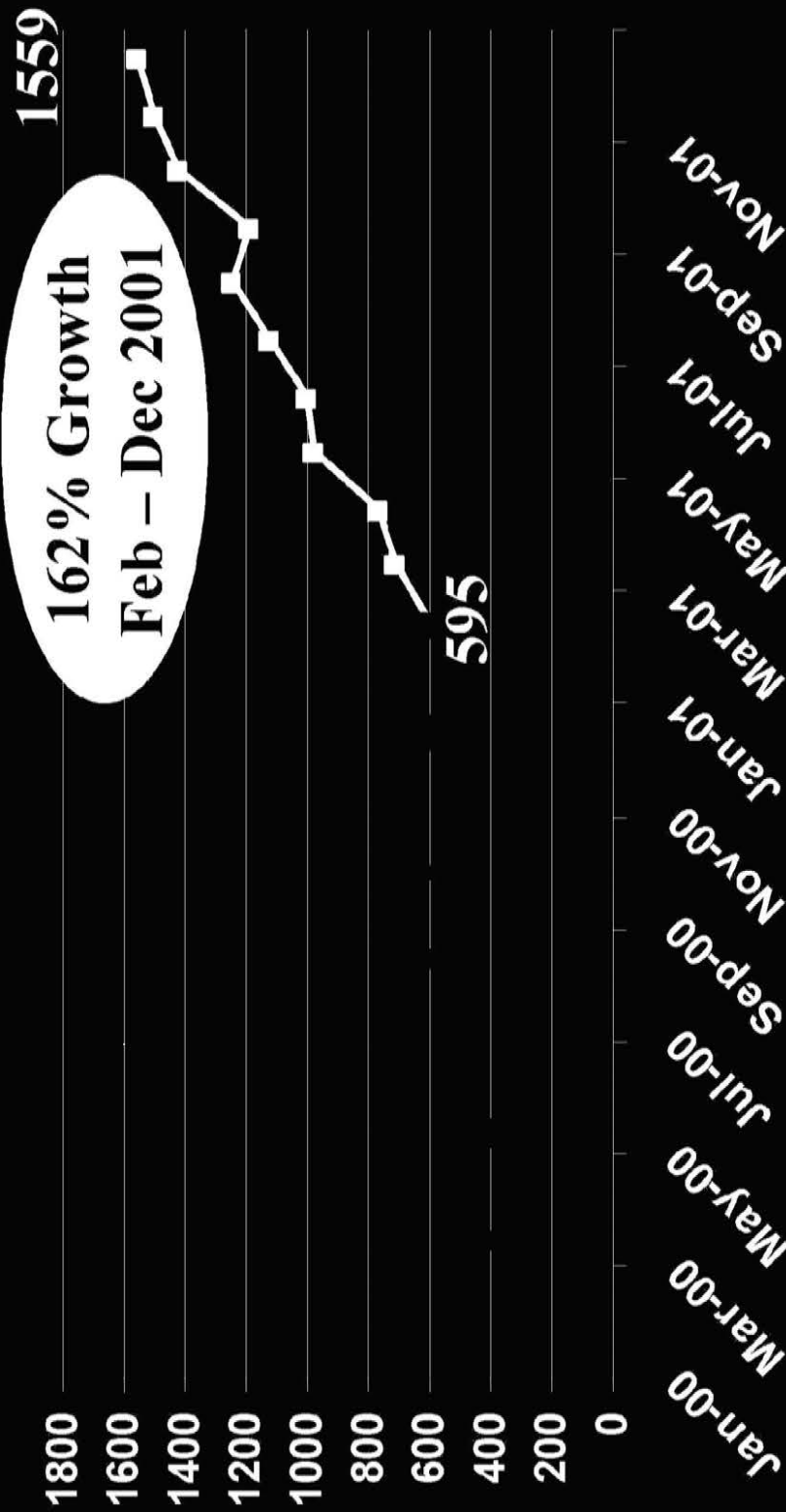

Produced Pursuant to Confidentiality Agreement

CEPHEDPA-AP-01581399

Confidential Treatment Requested by Cephalon, Inc.

CEP_TPP_EDPA10190748

TEVA_MDL_A_05734058

CONFIDENTIAL PER STIPULATION AND PROTECTIVE ORDER

Confidential

P-03609 _ 00013

Monthly TRx Trend Pre- and Post-Launch

Where will we be at the end of 2002?

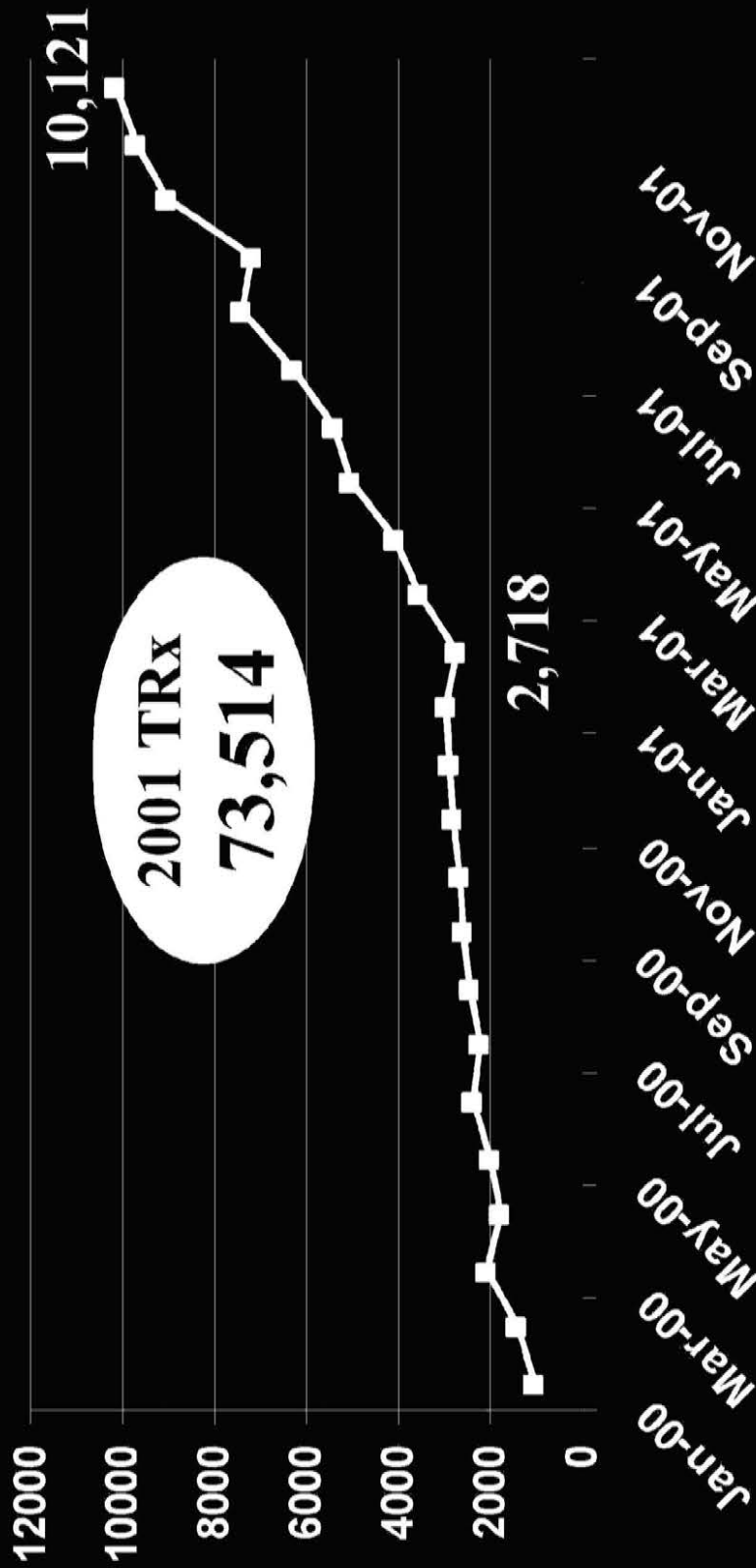

Produced Pursuant to Confidentiality Agreement

CEPHEDPA-AP-01581400

Confidential Treatment Requested by Cephalon, Inc.

CEP_TPP_EDPA10190749

TEVA_MDL_A_05734059

CONFIDENTIAL PER STIPULATION AND PROTECTIVE ORDER

Confidential

P-03609 _ 00014

Monthly Units and Units/Rx

Monthly TRx Units

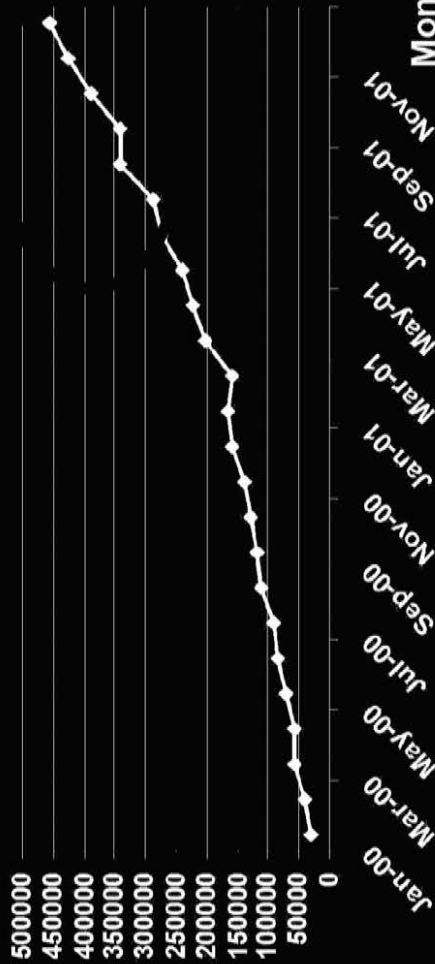

- Accelerated growth
- 190% growth Feb to Dec

Monthly Units / TRx

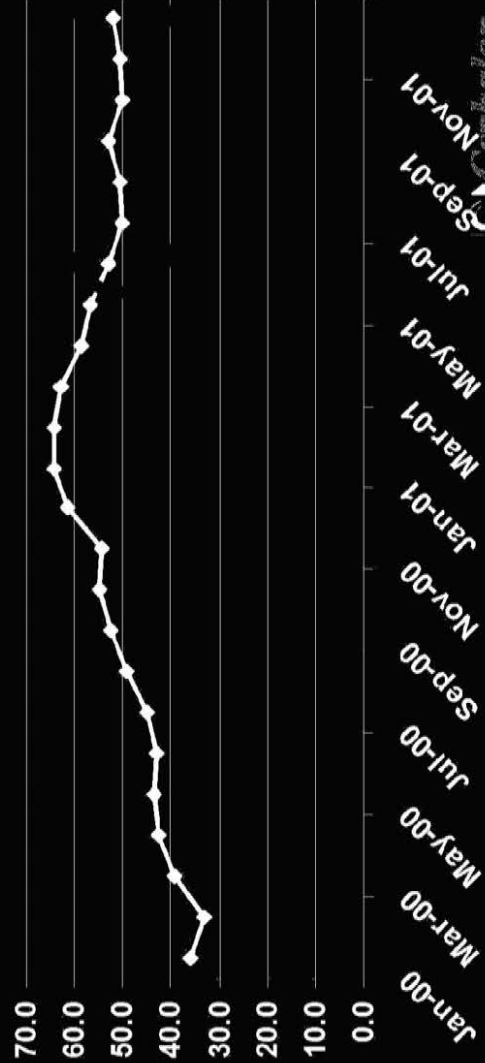

- Units/TRx steady
- Remains above 50



Produced Pursuant to Confidentiality Agreement

CEPHEDPA-AP-01581401

Confidential Treatment Requested by Cephalon, Inc.

CEP_TPP_EDPA10190750

TEVA_MDL_A_05734060

CONFIDENTIAL PER STIPULATION AND PROTECTIVE ORDER

Confidential

P-03609 _ 00015

Monthly Gross Sales Trend and Post-Launch

Q4 Gross Sales = \$22.5 MM

Avg. 23%
Month-to-Month Growth

2001 Gross Sales
\$55 MIM

\$9,000,000
\$8,000,000
\$7,000,000
\$6,000,000
\$5,000,000
\$4,000,000
\$3,000,000
\$2,000,000
\$1,000,000
\$0

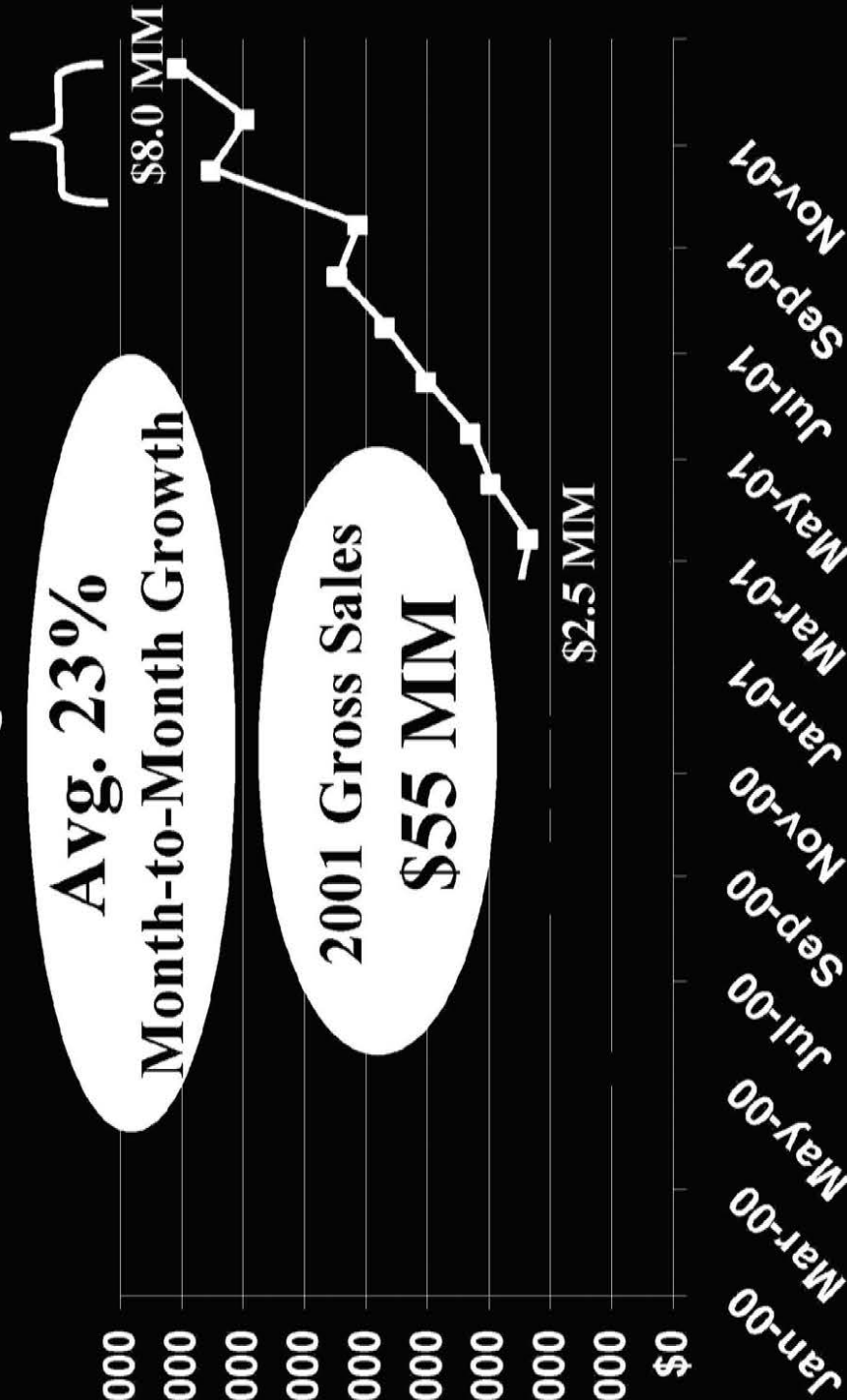

Actiq®
(oral transmucosal fentanyl citrate)

Cephalon

Produced Pursuant to Confidentiality Agreement

CEPHEDPA-AP-01581402

Confidential Treatment Requested by Cephalon, Inc.

CEP_TPP_EDPA10190751

TEVA_MDL_A_05734061

CONFIDENTIAL PER STIPULATION AND PROTECTIVE ORDER

Confidential

P-03609 _ 00016

Prescriber Base by Specialty January 2001 vs. December 2001

January 2001

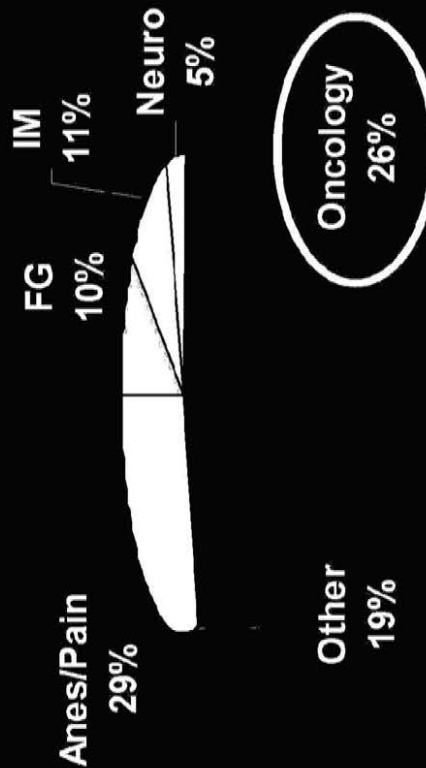

December 2001

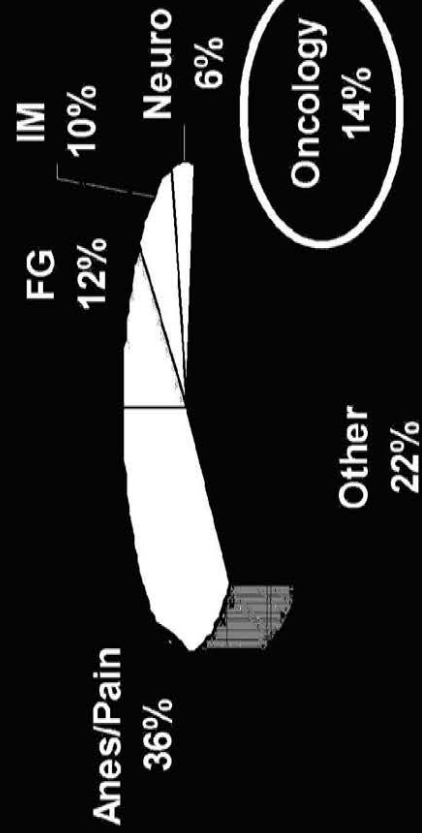

Actiq®
(oral transmucosal fentanyl citrate)

Cephalon

Produced Pursuant to Confidentiality Agreement

CEPHEDPA-AP-01581403

Confidential Treatment Requested by Cephalon, Inc.

CEP_TPP_EDPA10190752

TEVA_MDL_A_05734062

CONFIDENTIAL PER STIPULATION AND PROTECTIVE ORDER

Confidential

P-03609 _ 00017

Monthly Prescriber Count by Specialty Impact of Focused Targeting

- Tremendous growth in Anes/Pain
- Growth in every specialty!

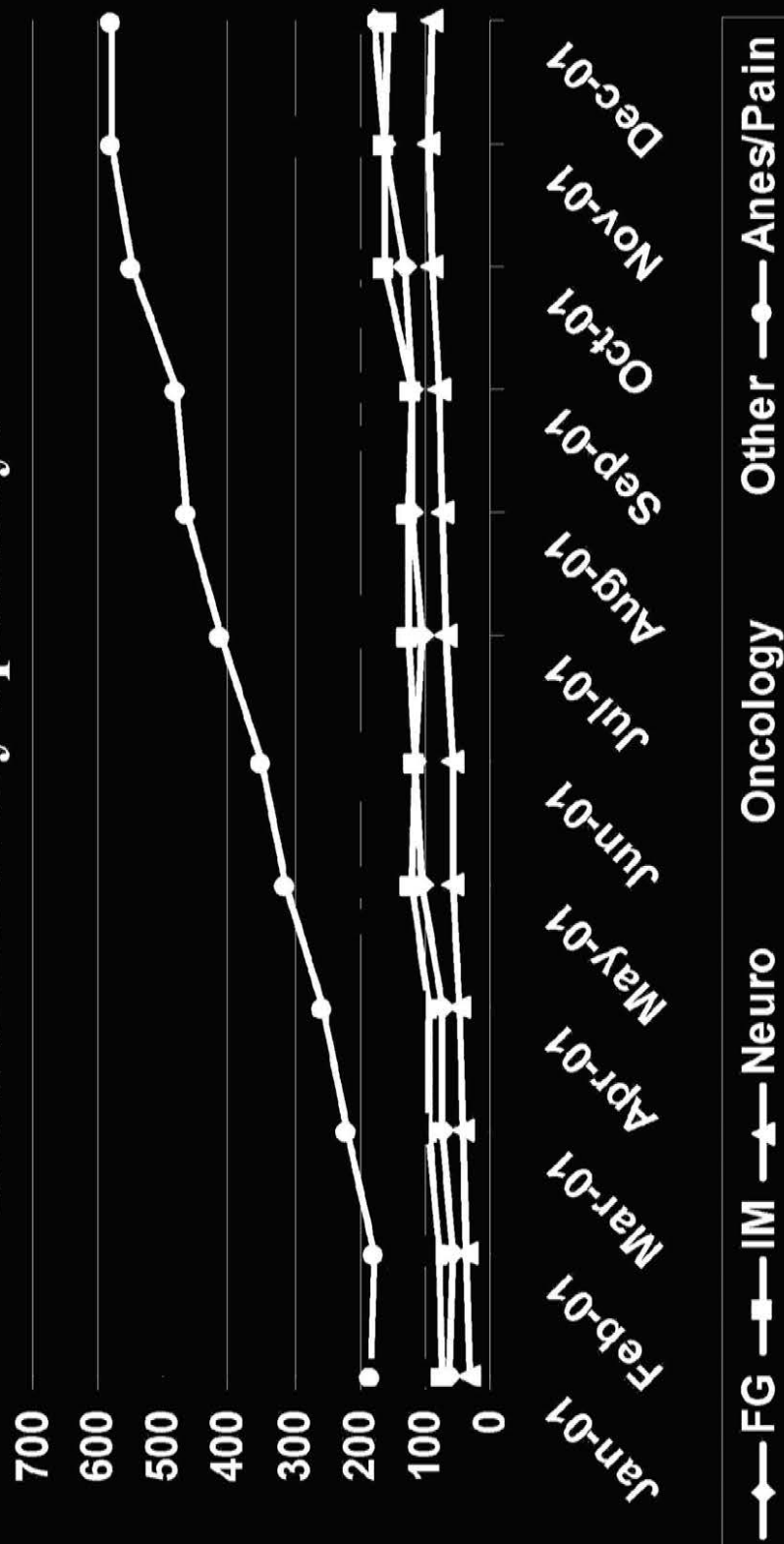

Produced Pursuant to Confidentiality Agreement

CEPHEDPA-AP-01581404

Confidential Treatment Requested by Cephalon, Inc.

CEP_TPP_EDPA10190753

TEVA_MDL_A_05734063

CONFIDENTIAL PER STIPULATION AND PROTECTIVE ORDER
Confidential

P-03609 _ 00018

TRx Trend by Specialty

Impact of Focused Targeting

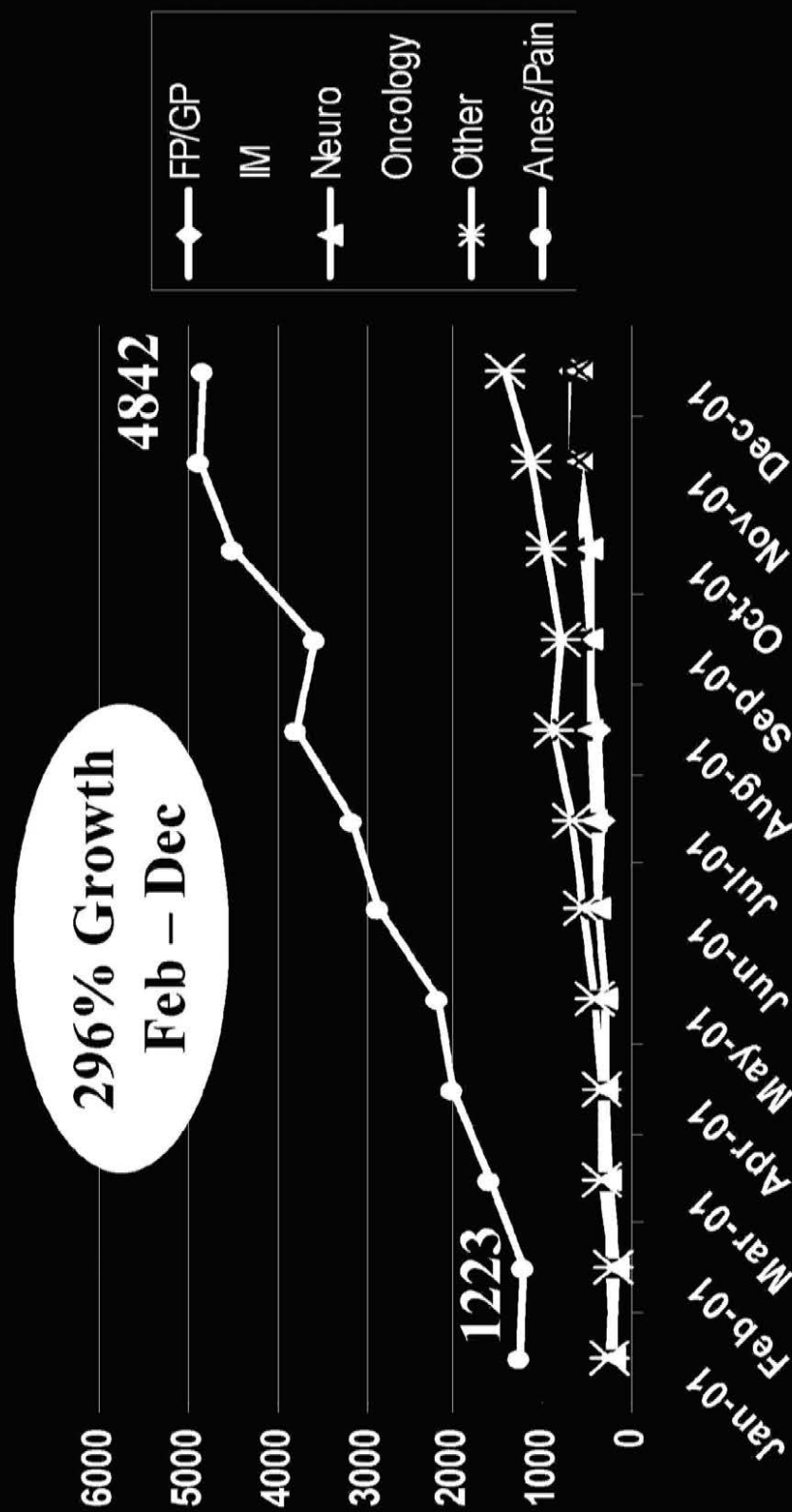

Produced Pursuant to Confidentiality Agreement

CEPHEDPA-AP-01581405
 Confidential Treatment Requested by Cephalon, Inc.
 CEP_TPP_EDPA10190754

CONFIDENTIAL PER STIPULATION AND PROTECTIVE ORDER
 Confidential

TEVA_MDL_A_05734064

P-03609 _ 00019

Average TRx/Prescriber by Specialty 2000 vs.

- Tremendous growth in Anes/Pain

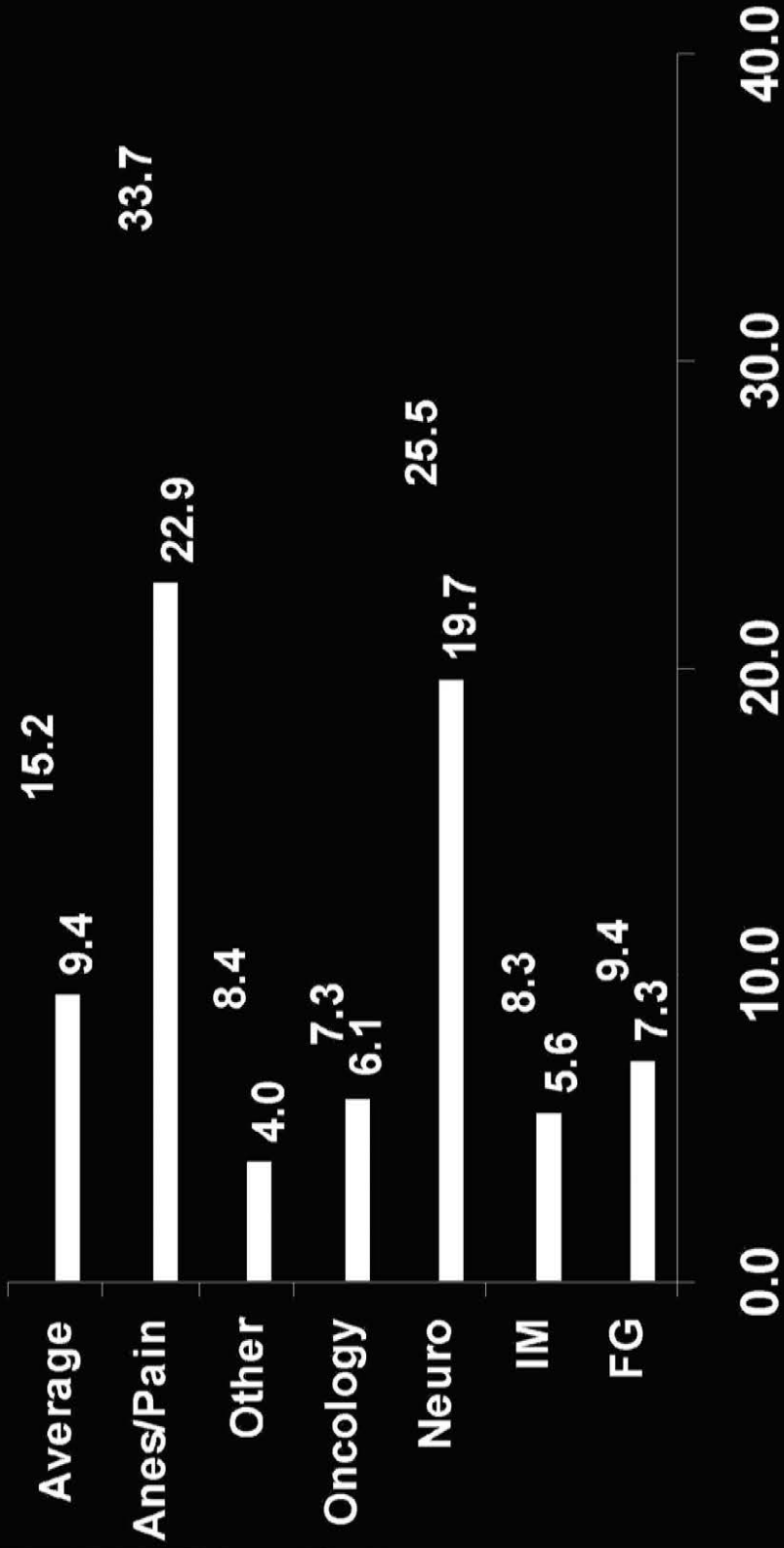

Actiq®
(oral transmucosal
fentanyl citrate)



Produced Pursuant to Confidentiality Agreement

CEPHEDPA-AP-01581406

Confidential Treatment Requested by Cephalon, Inc.

CEP_TPP_EDPA10190755

TEVA_MDL_A_05734065

CONFIDENTIAL PER STIPULATION AND PROTECTIVE ORDER

Confidential

P-03609 _ 00020

TRx Trend by Strength Impact of Titration Messaging

- 200mcg & 800mcg TRx growing at fastest rate
- Titration messaging has been effective

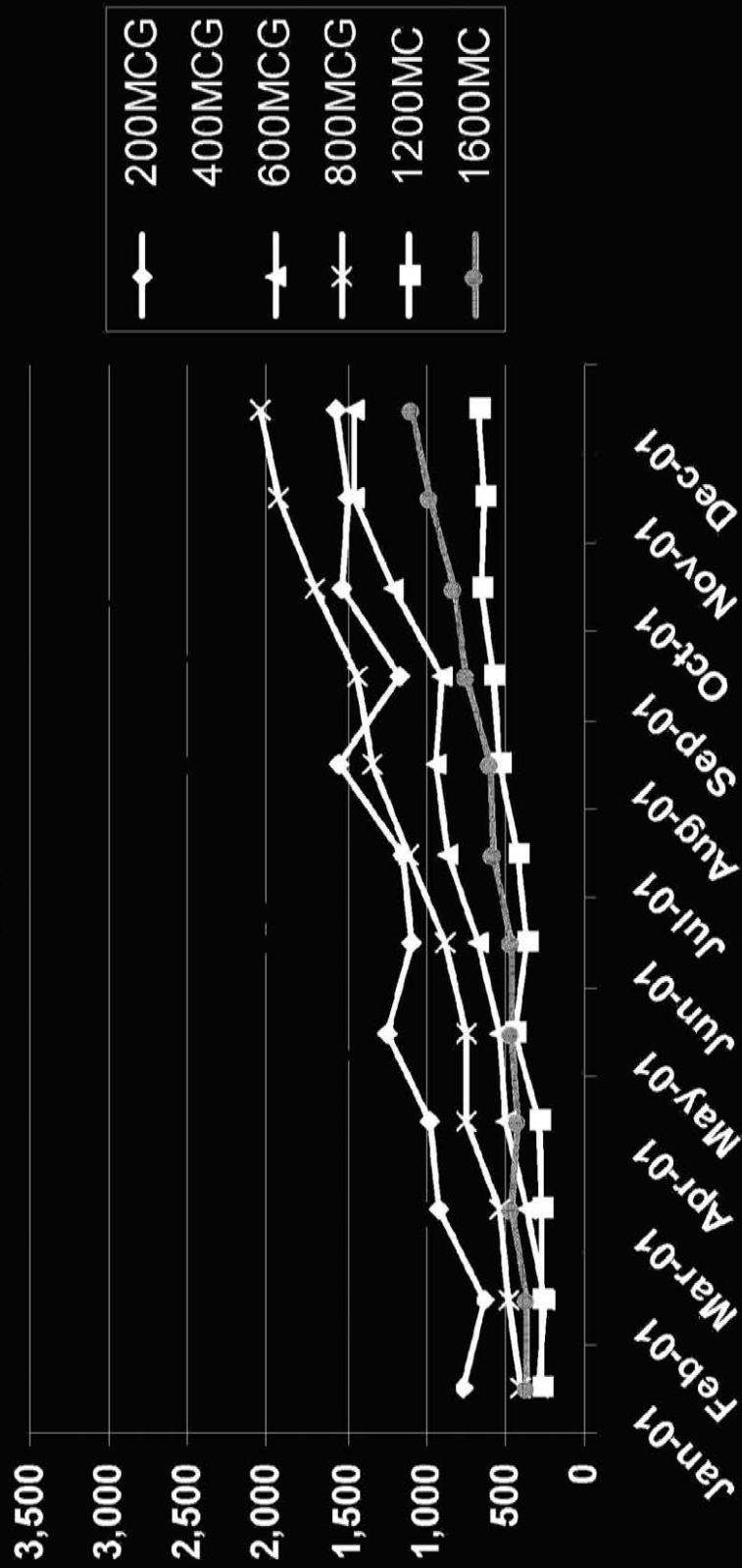

Produced Pursuant to Confidentiality Agreement

CEPHEDPA-AP-01581407

Confidential Treatment Requested by Cephalon, Inc.

CEP_TPP_EDPA10190756

TEVA_MDL_A_05734066

CONFIDENTIAL PER STIPULATION AND PROTECTIVE ORDER

Confidential

P-03609 _ 00021

Two Consultant Meetings San Diego Meetings – 2001

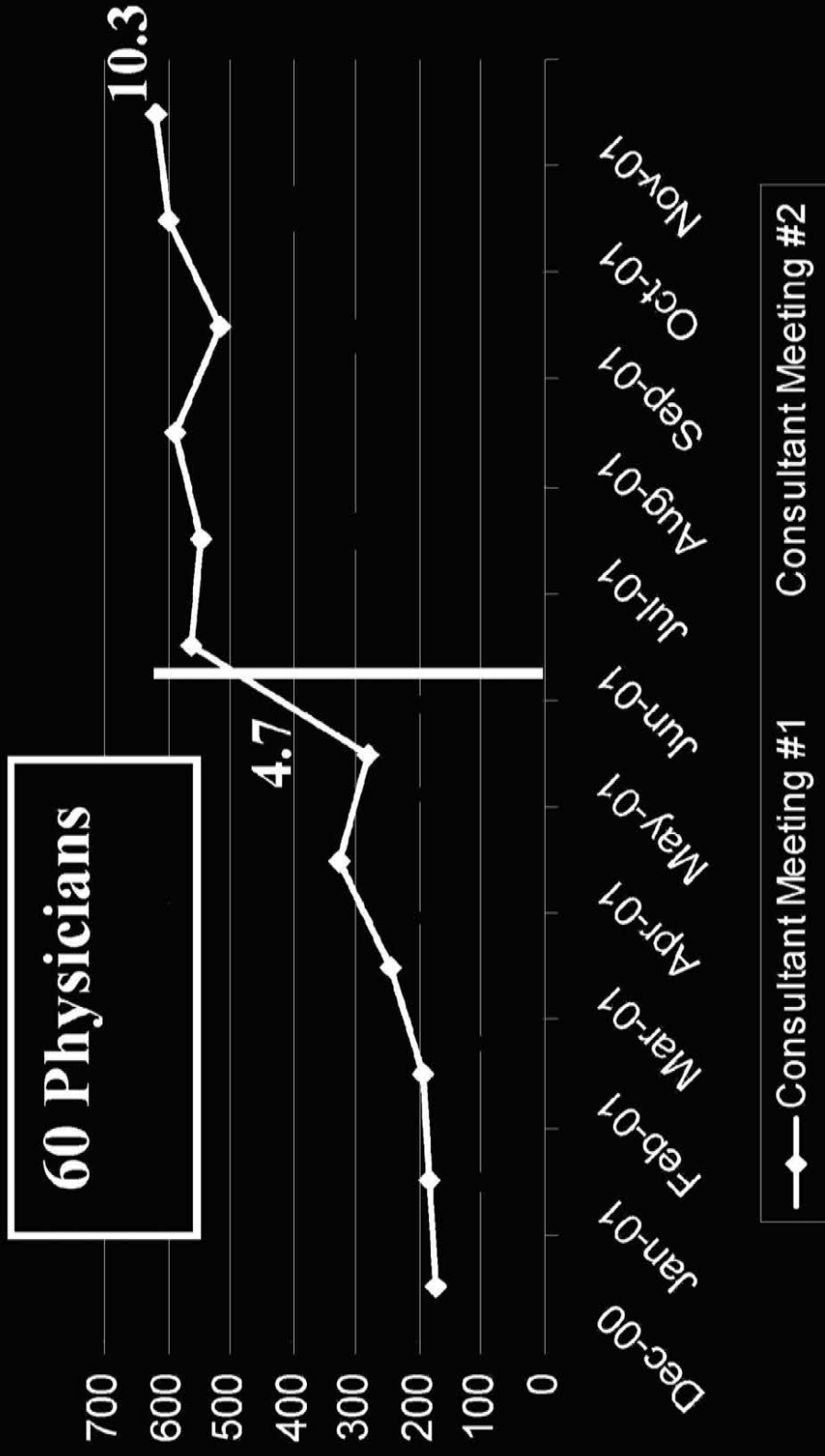

Produced Pursuant to Confidentiality Agreement

CONFIDENTIAL PER STIPULATION AND PROTECTIVE ORDER
Confidential

CEPHEDPA-AP-01581408
Confidential Treatment Requested by Cephalon, Inc.
CEP_TPP_EDPA10190757

TEVA_MDL_A_05734067

P-03609 _ 00022

2001 Performance Update Summary

Four Key Business Drivers

- **Prescriber Count**
 - ◆ Average month-to-month growth since relaunch: 17%
- **Total Prescriptions**
 - ◆ Average month-to-month growth since relaunch: 23%
- **Total Units**
 - ◆ Average month-to-month growth since relaunch: 10%
 - ◆ Units/Rx no longer in decline and above 50 units/Rx
- **TRx Strength**
 - ◆ 400 & 800 growing at fastest rate
- **Gross Factory Sales**
 - ◆ Average month-to-month growth since relaunch: 23%
 - ◆ 244% growth over 2000 (\$55.0 MM vs. \$16.0 MM)

Actiq®
(oral transmucosal
fentanyl citrate)

Cephalon

Produced Pursuant to Confidentiality Agreement

CEPHEDPA-AP-01581409

Confidential Treatment Requested by Cephalon, Inc.

CEP_TPP_EDPA10190758

TEVA_MDL_A_05734068

CONFIDENTIAL PER STIPULATION AND PROTECTIVE ORDER

Confidential

P-03609 _ 00023

Prescriber Productivity Summary

Full Year 2001

Specialty	% of Prescriber Base	% of TRx	% of Sales
FG	10%	7%	10%
IM	11%	8%	6%
Neuro	6%	7%	6%
Oncology	19%	11%	7%
Other	18%	12%	8%
Anes/Pain	35%	55%	62%

Specialty	Avg TRx/Prescriber	Avg Units/TRx
FG	9.4	65.9
IM	8.3	50.8
Neuro	25.5	50.7
Oncology	7.3	38.0
Other	8.4	45.4
Anes/Pain	33.7	57.6



Produced Pursuant to Confidentiality Agreement

CONFIDENTIAL PER STIPULATION AND PROTECTIVE ORDER

Confidential

CEPHEDPA-AP-01581410

Confidential Treatment Requested by Cephalon, Inc.

CEP_TPP_EDPA10190759

TEVA_MDL_A_05734069



P-03609 _ 00024

Why have we been successful?

- Targeting correct physician specialties
- Delivering ACTIQ's key messages (benefits of rapid onset)
- Implementing appropriate and effective medical education programs
 - ❖ Sales-driven MEPs
 - ❖ Consultant meetings
 - ❖ CME programs; newsletter, website, teletopics, symposia
- Educating key physician targets
 - ❖ Titration process
 - ❖ Relative potency of ACTIQ
 - ❖ Patient selection
- Improving product awareness
 - ❖ Media plan (journal ads)
 - ❖ Convention presence
 - ❖ Direct mailings (medical & promotional)

Actiq[®]
(oral transmucosal
fentanyl citrate)

Cephalon

Produced Pursuant to Confidentiality Agreement

CEPHEDPA-AP-01581411

Confidential Treatment Requested by Cephalon, Inc.

CEP_TPP_EDPA10190760

TEVA_MDL_A_05734070

CONFIDENTIAL PER STIPULATION AND PROTECTIVE ORDER

Confidential

P-03609 _ 00025

Why ACTIQ in 2002...and beyond?

Actiq[®]
(oral transmucosal
fentanyl citrate)

Produced Pursuant to Confidentiality Agreement

CONFIDENTIAL PER STIPULATION AND PROTECTIVE ORDER
Confidential

CEPHEDPA-AP-01581412
Confidential Treatment Requested by Cephalon, Inc.
CEP_TPP_EDPA10190761

TEVA_MDL_A_05734071

P-03609 _ 00026

Differentiation of ACTIQ

- Why ACTIQ and not another short-acting opioid?
- ACTIQ's key differentiating benefit meets a critical unmet need
- Rapid onset of analgesia
 - Critical feature in treating BTP and episodic pain

Actiq[®]
(oral transmucosal
fentanyl citrate)

Cephalon

Produced Pursuant to Confidentiality Agreement

CEPHEDPA-AP-01581413

Confidential Treatment Requested by Cephalon, Inc.

CEP_TPP_EDPA10190762

TEVA_MDL_A_05734072

CONFIDENTIAL PER STIPULATION AND PROTECTIVE ORDER

Confidential

P-03609 _ 00027

2002 ACTIQ Positioning

- ACTIQ is
 - ↳ a medication in a unique oral transmucosal delivery system
 - ↳ that provides the most rapid onset of analgesia of any non-invasive opioid formulation available
 - ↳ and affords patients personal pain control for BTP and episodic pain

Actiq[®]
(oral transmucosal
fentanyl citrate)

Cephalon

Produced Pursuant to Confidentiality Agreement

CEPHEDPA-AP-01581414

Confidential Treatment Requested by Cephalon, Inc.

CEP_TPP_EDPA10190763

TEVA_MDL_A_05734073

CONFIDENTIAL PER STIPULATION AND PROTECTIVE ORDER

Confidential

P-03609 _ 00028

2002 ACTIQ Key Messages

Messages may appear differently in promotional materials

■ ACTIQ

- ✦ Provides rapid onset of analgesia*
- ✦ Provides personal pain control by improving functionality and QoL*
- ✦ Has a unique, revolutionary drug delivery system
- ✦ Is most effective when titration is initiated at 400mcg
- ✦ Is safe and highly effective*
- ✦ Is easy and convenient to use*
- ✦ Is the only product specifically indicated for BTCP

* Characteristics of ACTIQ which rated extremely high in market research “satisfaction ratings”

Actiq®
(oral transmucosal fentanyl citrate)

Cephalon

Produced Pursuant to Confidentiality Agreement

CEPHEDPA-AP-01581415

Confidential Treatment Requested by Cephalon, Inc.

CEP_TPP_EDPA10190764

TEVA_MDL_A_05734074

CONFIDENTIAL PER STIPULATION AND PROTECTIVE ORDER

Confidential

P-03609 _ 00029

2002 Key Marketing Issues

Actiq®
(oral transmucosal
fentanyl citrate)

Produced Pursuant to Confidentiality Agreement

CEPHEDPA-AP-01581416

Confidential Treatment Requested by Cephalon, Inc.

CEP_TPP_EDPA10190765

TEVA_MDL_A_05734075

CONFIDENTIAL PER STIPULATION AND PROTECTIVE ORDER

Confidential

P-03609 _ 00030

2002 Key Marketing Issues

1. **Low product awareness among targeted physician specialties (especially “awareness” linked to key benefits)**
2. **Lack of knowledge in the assessment and treatment of BTP and episodic pain among targeted physician specialties**
3. **Limited clinical data and publications outside of cancer patient population and supporting simplified titration**
4. **Low product and disease state awareness among pain patients**
5. **Limited direct promotional reach**

Actiq®
(oral transmucosal
fentanyl citrate)

Cephalon

Produced Pursuant to Confidentiality Agreement

CEPHEDPA-AP-01581417

Confidential Treatment Requested by Cephalon, Inc.

CEP_TPP_EDPA10190766

TEVA_MDL_A_05734076

CONFIDENTIAL PER STIPULATION AND PROTECTIVE ORDER

Confidential

P-03609 _ 00031

The Big Questions

How will we:

- Address these key issues
- Deliver ACTIQ's key messages
- Effectively position the product in 2002?
 - Continue to utilize current brand concept
 - Establish appropriate strategies
 - ◆ No real change in direction
 - Execute effective tactics
 - ◆ We will review shortly

Actiq[®]
(oral transmucosal
fentanyl citrate)

Cephalon

Produced Pursuant to Confidentiality Agreement

CEPHEDPA-AP-01581418

Confidential Treatment Requested by Cephalon, Inc.

CEP_TPP_EDPA10190767

TEVA_MDL_A_05734077

CONFIDENTIAL PER STIPULATION AND PROTECTIVE ORDER

Confidential

P-03609 _ 00032

Positioning Conveyed Through Brand Concept



Produced Pursuant to Confidentiality Agreement

CONFIDENTIAL PER STIPULATION AND PROTECTIVE ORDER
Confidential

CEPHEDPA-AP-01581419
Confidential Treatment Requested by Cephalon, Inc.
CEP_TPP_EDPA10190768

TEVA_MDL_A_05734078

P-03609 _ 00033

Strategically Addressing Key Issues



Actiq®
(oral transmucosal fentanyl citrate)

Cephalon

Produced Pursuant to Confidentiality Agreement

CONFIDENTIAL PER STIPULATION AND PROTECTIVE ORDER
Confidential

CEPHEDPA-AP-01581420
Confidential Treatment Requested by Cephalon, Inc.
CEP_TPP_EDPA10190769

TEVA_MDL_A_05734079

2002 Selected Tactics

Actiq[®]
(oral transmucosal
fentanyl citrate)

Produced Pursuant to Confidentiality Agreement

CONFIDENTIAL PER STIPULATION AND PROTECTIVE ORDER
Confidential

CEPHEDPA-AP-01581421
Confidential Treatment Requested by Cephalon, Inc.
CEP_TPP_EDPA10190770

TEVA_MDL_A_05734080

P-03609 _ 00035

2002 Selected Tactics

- Consultant Meetings
- CME / CE
- Promotional Materials

Actiq®
(oral transmucosal
fentanyl citrate)

Cephalon

Produced Pursuant to Confidentiality Agreement

CONFIDENTIAL PER STIPULATION AND PROTECTIVE ORDER
Confidential

CEPHEDPA-AP-01581422
Confidential Treatment Requested by Cephalon, Inc.
CEP_TPP_EDPA10190771

TEVA_MDL_A_05734081

P-03609 _ 00036

Consultants Meetings

- March 22-24 Ft. Lauderdale, FL
- June 21-23 San Diego, CA
- October 25-27 Dallas, TX

↳ Targeting 60 physicians at each meeting

↳ Objectives

- Drive scripts
- Identify speakers / champions

Actiq®
(oral transmucosal
fentanyl citrate)

Cephalon

Produced Pursuant to Confidentiality Agreement

CEPHEDPA-AP-01581423

Confidential Treatment Requested by Cephalon, Inc.

CEP_TPP_EDPA10190772

TEVA_MDL_A_05734082

CONFIDENTIAL PER STIPULATION AND PROTECTIVE ORDER

Confidential

P-03609 _ 00037

CME / CE

- **Five Key Initiatives**
 - ↳ 3 programs extended from 2001
 - **Newsletter: Emerging Solutions in Pain**
 - **Symposia**
 - **Website: *EmergingSolutionsinPain.com***
- ↳ 2 new programs
 - **Breakthrough Pain Category on *Pain.com***
 - **Teleconferences**

Actiq®
(oral transmucosal
fentanyl citrate)

Cephalon

Produced Pursuant to Confidentiality Agreement

CEPHEDPA-AP-01581424
Confidential Treatment Requested by Cephalon, Inc.
CEP_TPP_EDPA10190773

CONFIDENTIAL PER STIPULATION AND PROTECTIVE ORDER
Confidential

TEVA_MDL_A_05734083

P-03609 _ 00038

CME / CE – Extended Programs

1. Newsletter

- ◆ 1st Newsletter mailed November 2001
- ◆ 2002 – Trimesterly
 - February, June & October
 - Will allow for varied topics and create a credible CME resource
- ◆ Circulation of 10K (80% MDs)
 - BRCs mailed to original mailing list
 - ◆ Reps will be provided with BRCs
 - ◆ Clinicians / Reps can sign up at website

Actiq®
(oral transmucosal
fentanyl citrate)

Cephalon

Produced Pursuant to Confidentiality Agreement

CEPHEDPA-AP-01581425

Confidential Treatment Requested by Cephalon, Inc.

CEP_TPP_EDPA10190774

TEVA_MDL_A_05734084

CONFIDENTIAL PER STIPULATION AND PROTECTIVE ORDER

Confidential

P-03609 _ 00039

CME Newsletter

*Emerging Solutions
in Pain*
www.EmergingSolutionsinPain.com

Spring 2002
Volume 11
Number 1

An educational resource
for clinicians in the field
of pain management

Provided by:
 MediCom
Worldwide, Inc.

In this issue...

The Clinical Expert

Dr. Jeffrey A. Gudim reviews a recent regional symposium addressing the new JCAHO Pain Management Standards.

The Clinical Experience

An independent study CD-ROM program presented by Dr. Steven Passik discussing substance abuse issues and chronic pain.

For additional continuing education opportunities, please visit us at:

www.EmergingSolutionsinPain.com

MediCom gratefully acknowledges the receipt of an educational grant in support of this publication from Cephalon, Inc.



©2002, MediCom Worldwide, Inc.
101 Washington St., Morrisville, PA 19067

No portion of this material may be copied or duplicated without the expressed permission of MediCom.

Produced Pursuant to Confidentiality Agreement

Confidential

CONFIDENTIAL PER STIPULATION AND PROTECTIVE ORDER

Confidential Treatment Requested by Cephalon, Inc.

CEPHEDPA-AP-01581426

CEP_TPP_EDPA10190775

TEVA_MDL_A_05734085

Business Reply Card



To continue receiving your complimentary subscription to *Emerging Solutions in Pain*, please fill out this form and return it to MedCom Worldwide, Inc. via mail, fax (215-337-0900) or online at www.EmergingSolutionsinPain.com

Free subscriptions are available only to those who hold one of the positions in Pain Management listed below. If you do not qualify, paid subscriptions are available and can be ordered by calling 800-408-4242. Thank you!

A subscription offer for updates and continuous *pain*

- Yes! I want to receive complimentary quarterly publications of *Emerging Solutions in Pain!*
- No thank you.

Specialty: Please check which best describes your position and/or specialty:

- Pain Management
- Oncology
- Anesthesiology
- Internal Medicine
- Primary Care
- MD
- DO
- RN
- NP
- Other: _____

Name: _____

Title: _____

Institution: _____

Department: _____

Address: _____

Address: _____

City/State: _____

Postal/Zip Code: _____ Country: _____

Telephone: (____) _____ Fax: (____) _____

Email Address: _____

Signature: _____ Date: _____

Produced Pursuant to Confidentiality Agreement
CONFIDENTIAL PER STIPULATION AND PROTECTIVE ORDER
Confidential

CEPHEDPA-AP-01581427
Confidential Treatment Requested by Cephalon, Inc.
CEP_TPP_EDPA10190776
TEVA_MDL_A_05734086

CME / CE – Extended Programs

2. Symposia

- ◆ Different strategy than in 2001
 - 25 cities with target of 20-30 MDs per program
 - Fewer presenters / topics
 - ❖ BTP & Abuse, Addiction, Diversion
 - Expanded reach with concentrated effort
 - Major rep involvement with physician recruitment
- ◆ Timing: February through November 2002

Actiq®
(oral transmucosal
fentanyl citrate)

Cephalon

Produced Pursuant to Confidentiality Agreement

CEPHEDPA-AP-01581428

Confidential Treatment Requested by Cephalon, Inc.

CEP_TPP_EDPA10190777

TEVA_MDL_A_05734087

CONFIDENTIAL PER STIPULATION AND PROTECTIVE ORDER

Confidential

P-03609 _ 00042

Symposia Invitation

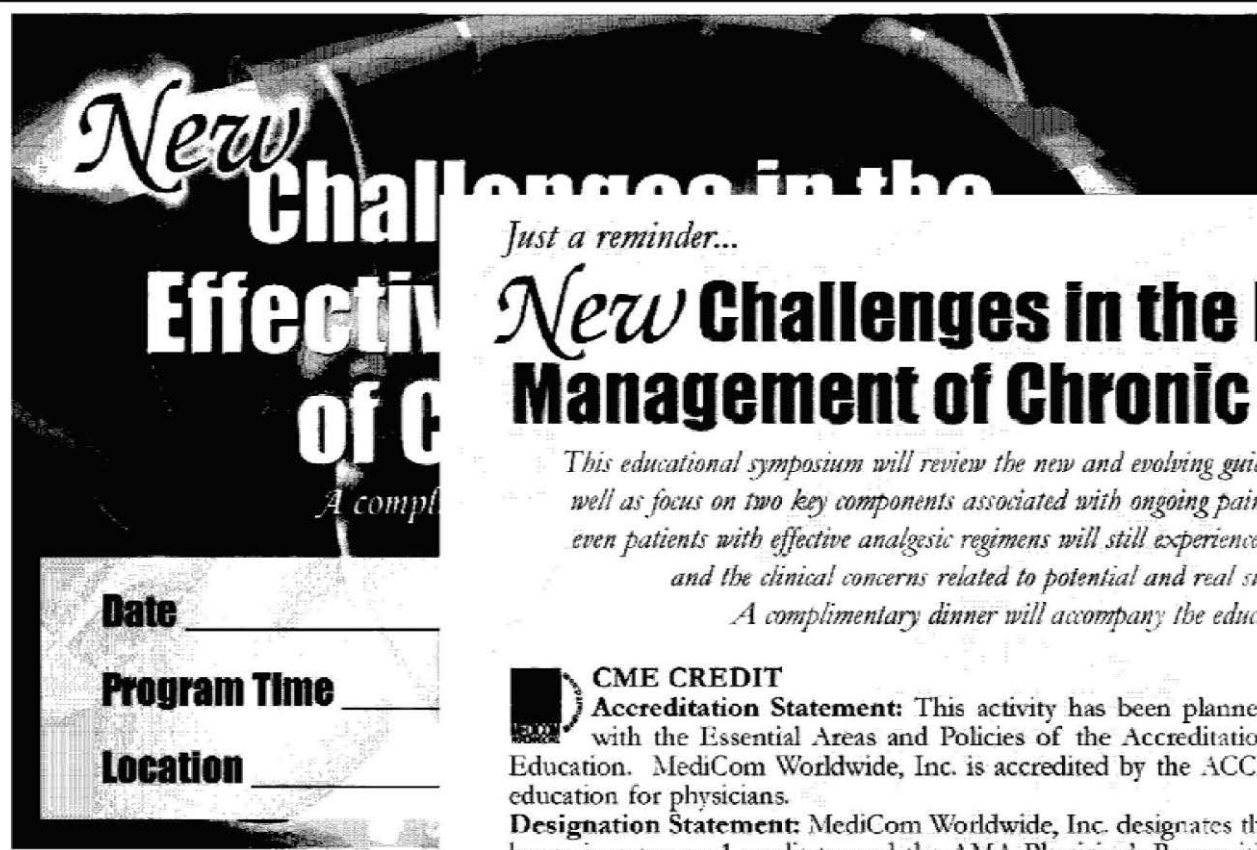

Just a reminder...

New Challenges in the Effective Management of Chronic Pain

This educational symposium will review the new and evolving guidelines on pain management, as well as focus on two key components associated with ongoing pain management: recognition that even patients with effective analgesic regimens will still experience occasional breakthrough pain and the clinical concerns related to potential and real substance abuse issues.

A complimentary dinner will accompany the educational activity.



CME CREDIT

Accreditation Statement: This activity has been planned and implemented in accordance with the Essential Areas and Policies of the Accreditation Council for Continuing Medical Education. MediCom Worldwide, Inc. is accredited by the ACCME to provide continuing medical education for physicians.

Designation Statement: MediCom Worldwide, Inc. designates this educational activity for up to 1.5 hours in category 1 credit toward the AMA Physician's Recognition Award. Each physician should claim only those hours of credit that he/she actually spent completing the educational activity.

To register for this program, please call **800-408-4242, ext. 33.**

Supported by an educational grant from Cephalon, Inc.  **Cephalon**

Date _____
Program Time _____
Location _____

Produced Pursuant to Confidentiality Agreement

Confidential

CONFIDENTIAL PER STIPULATION AND PROTECTIVE ORDER

Confidential Treatment Requested by Cephalon, Inc.

CEPHEDPA-AP-01581429

CEP_TTP_EDPA10190778

TEVA_MDL_A_05734088

CME / CE – Extended Programs

3. *EmergingSolutionsinPain.com*

- ↳ Launched August 2001
- ↳ Repository of all programs
 - Creates enduring materials for rep referral
 - Registration for newsletter / future programs

Actiq®
(oral transmucosal
fentanyl citrate)

Cephalon

Produced Pursuant to Confidentiality Agreement

CEPHEDPA-AP-01581430

Confidential Treatment Requested by Cephalon, Inc.

CEP_TPP_EDPA10190779

TEVA_MDL_A_05734089

CONFIDENTIAL PER STIPULATION AND PROTECTIVE ORDER

Confidential

P-03609 _ 00044

CME Website: *EmergingSolutionsinPain.com*

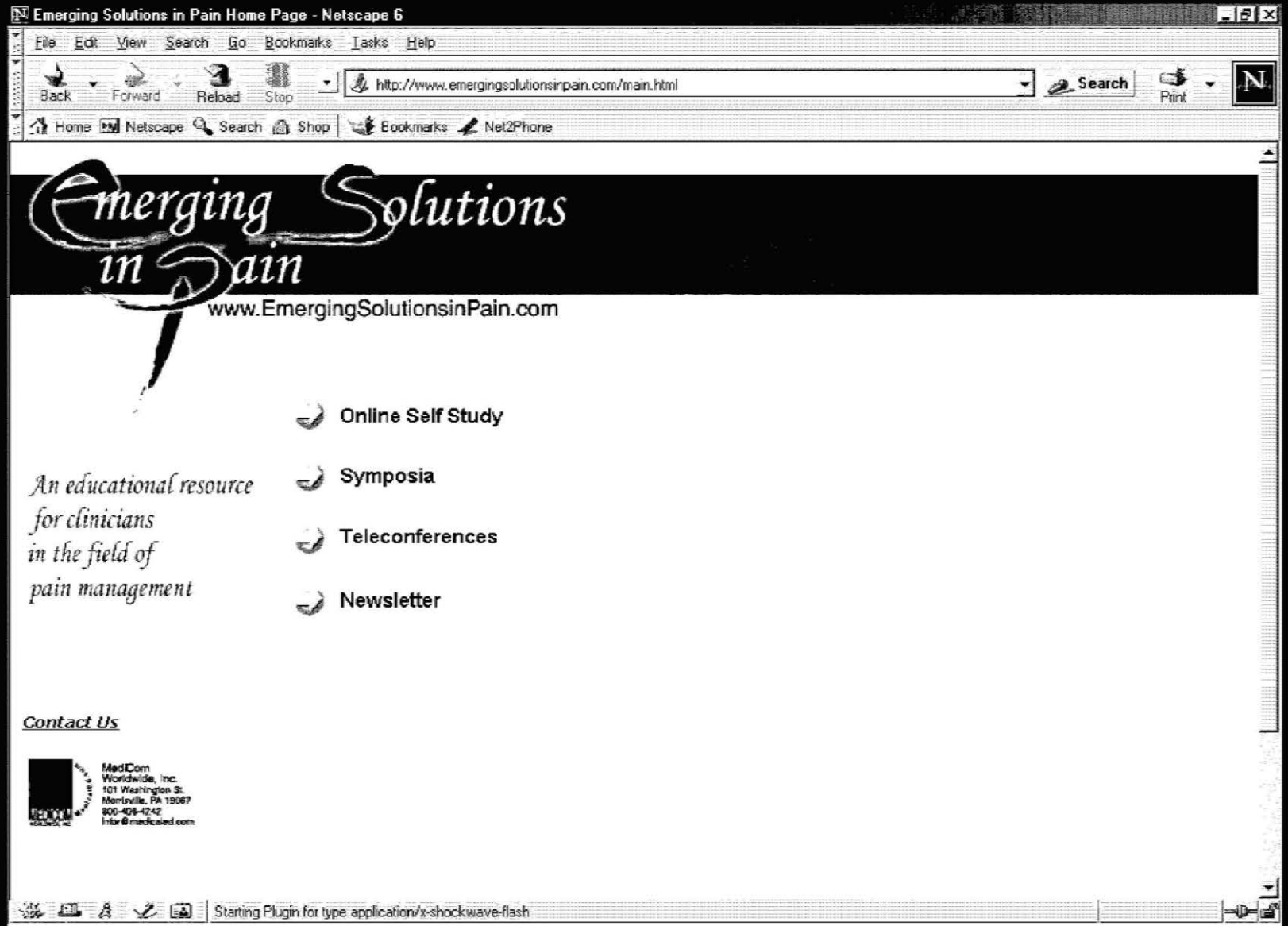

Produced Pursuant to Confidentiality Agreement

Confidential

CONFIDENTIAL PER STIPULATION AND PROTECTIVE ORDER

CEPHEDPA-AP-01581431

Confidential Treatment Requested by Cephalon, Inc.

CEP_TTP_EDPA10190780

TEVA_MDL_A_05734090

CME / CE – New Programs

1. Breakthrough Pain Category on *Pain.com*

- Most popular “pain” website (200K hits/month)
 - ❖ Dannemiller Memorial Educational Foundation
- Cephalon is sole sponsor of “Breakthrough Pain” category
 - ❖ Unique URL: *Pain.com/breakthroughpain*
- Initial core offerings include:
 - ❖ CME/CE module on BTP (10 studies abstracted)
 - ❖ Expert interviews (with site editor and guest MD)
 - ❖ Selected articles on BTP
 - ❖ Case histories
 - ❖ Patient education and information resources
 - ❖ Ask the Pain Doctor
 - ❖ FAQs
- Additional CME offerings / updates every 3 to 6 months
- Targeted Launch: Q3 2002

Actiq®
(oral transmucosal
fentanyl citrate)

Cephalon

Produced Pursuant to Confidentiality Agreement

CEPHEDPA-AP-01581432

Confidential Treatment Requested by Cephalon, Inc.

CEP_TPP_EDPA10190781

TEVA_MDL_A_05734091

CONFIDENTIAL PER STIPULATION AND PROTECTIVE ORDER

Confidential

P-03609 _ 00046

CME / CE – New Programs

2. Teleconferences

- ◆ **Pilot program – only 6 in 2002**
- ◆ **Topic: Treatment Advances in CRPS**
- ◆ **Timing: June – Aug 2002**
- ◆ **Targeting 20-30 MDs/call**
 - **If successful, additional dates possible**

Actiq®
(oral transmucosal
fentanyl citrate)

Cephalon

Produced Pursuant to Confidentiality Agreement

CONFIDENTIAL PER STIPULATION AND PROTECTIVE ORDER
Confidential

CEPHEDPA-AP-01581433
Confidential Treatment Requested by Cephalon, Inc.
CEP_TPP_EDPA10190782

TEVA_MDL_A_05734092

P-03609 _ 00047

Promotional Materials Update

Actiq®
(oral transmucosal
fentanyl citrate)

Produced Pursuant to Confidentiality Agreement

CEPHEDPA-AP-01581434

Confidential Treatment Requested by Cephalon, Inc.

CEP_TPP_EDPA10190783

TEVA_MDL_A_05734093

CONFIDENTIAL PER STIPULATION AND PROTECTIVE ORDER

Confidential

P-03609 _ 00048

2001 Core Promotional Materials

Available Now:

- 2001 Sales Aid
- Patient FAQs
- Physician FAQs
- Dosing Guide (old concept)
- Product Monograph
- Reimbursement Brochure
- Pain Assessment Tear Sheet (non-branded)
- 3 Non-ACTIQ Specific Reprints

Actiq®
(oral transmucosal
fentanyl citrate)

Cephalon

Produced Pursuant to Confidentiality Agreement

CEPHEDPA-AP-01581435

Confidential Treatment Requested by Cephalon, Inc.

CEP_TPP_EDPA10190784

TEVA_MDL_A_05734094

CONFIDENTIAL PER STIPULATION AND PROTECTIVE ORDER

Confidential

P-03609 _ 00049

2002 Additions

Available Soon:

- 5 ACTIQ-specific Reprints
- Non-branded BTP Wall Chart
- New “Pocket-Size” Dosing Guide
- New PCS Coupons (with dosing instructions)
- Patient Instructional Use Tear Sheet
- 2001 Sales Aid – Revised
- Medi-Message Pads
- New Magnet & Rolodex Card
- ACTIQ.com

Actiq®
(oral transmucosal
fentanyl citrate)

Cephalon

Produced Pursuant to Confidentiality Agreement

CEPHEDPA-AP-01581436

Confidential Treatment Requested by Cephalon, Inc.

CEP_TPP_EDPA10190785

TEVA_MDL_A_05734095

CONFIDENTIAL PER STIPULATION AND PROTECTIVE ORDER

Confidential

P-03609 _ 00050

2002 Additions

Other Possibilities:

- Competitive Comparison PK Sales Aid
- Patient Profile Flash Cards
- Formulary Kit
- Promotional Direct Mailings

Giveaways:

- 3 Different Style Pens
- Travel Coffee Mugs
- Medi-Message Pads
- And last but not least...

Actiq®
(oral transmucosal
fentanyl citrate)

Cephalon

Produced Pursuant to Confidentiality Agreement

CONFIDENTIAL PER STIPULATION AND PROTECTIVE ORDER
Confidential

CEPHEDPA-AP-01581437
Confidential Treatment Requested by Cephalon, Inc.
CEP_TPP_EDPA10190786

TEVA_MDL_A_05734096

P-03609 _ 00051

Critical Success Factors for 2002

Marketing & Sales

- Creation of key sales aids/promotional pieces
- Modification of Brand Concept
- Implementation of Public Relations Plan
- PCS-driven MEPS
- CME Programs
- Consultant Meetings

Actiq®
(oral transmucosal
fentanyl citrate)

Cephalon

Produced Pursuant to Confidentiality Agreement

CONFIDENTIAL PER STIPULATION AND PROTECTIVE ORDER
Confidential

CEPHEDPA-AP-01581438
Confidential Treatment Requested by Cephalon, Inc.
CEP_TPP_EDPA10190787

TEVA_MDL_A_05734097

P-03609 _ 00052